

SYMBOLS USED IN RAILWAY SIGNALLING

SEMAPHORE SIGNALS

DESCRIPTION	SYMBOLS
Stop Signal रोक सिगनल	
Warner /Distant Signal चेतावनी/दूरस्थ सिगनल	
Stop Signal For Dock Platform रोक सिगनल डॉक प्लेटफार्म के लिये	
Stop Signal For Good Line रोक सिगनल गुड्स लाईन के लिये	
Loco Shunt Signal लोको शन्ट सिगनल	
Gate Signal गेट सिगनल	

DESCRIPTION	SYMBOLS
<p>Signal Not In Use</p> <p>सिगनल जो प्रयोग में न हो</p>	
<p>Signal With Reverser</p> <p>रिवर्सर लगा हुआ सिगनल</p>	
<p>Motor Operated Signal</p> <p>सिगनल मोटर चालित</p>	
<p>Signal Controlled By Token</p> <p>टोकन द्वारा नियंत्रित सिगनल</p>	
<p>Signal Controlled By Lock & Block</p> <p>लॉक व ब्लॉक द्वारा नियंत्रित सिगनल</p>	
<p>Signal Slot Control (Reverser Operated)</p> <p>सिगनल स्लॉट नियंत्रण (रिवर्सर चालित)</p>	

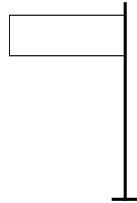
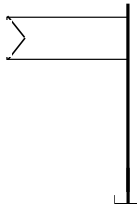
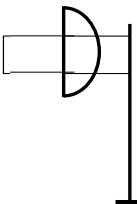
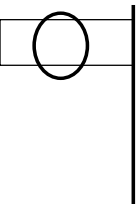
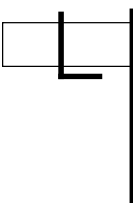
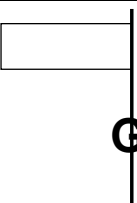
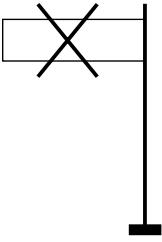
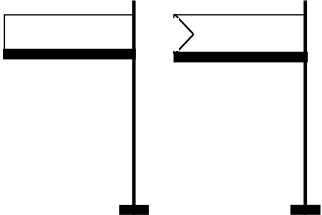
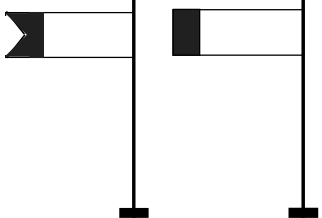
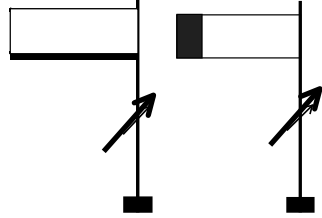
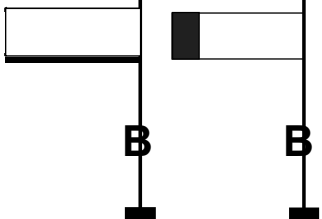
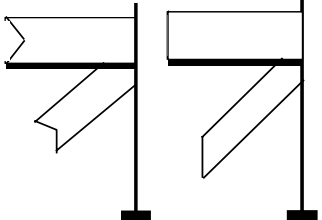
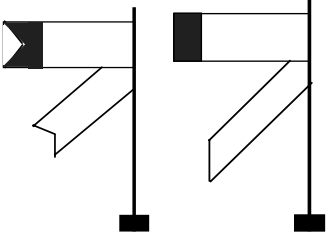
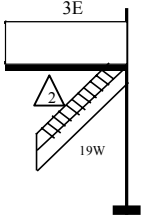
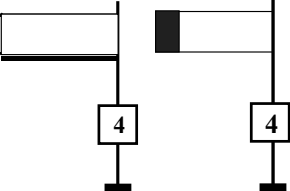
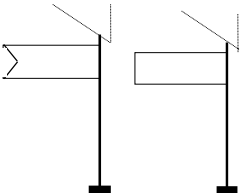

DESCRIPTION	SYMBOLS
<p>Signal Slot Control (Motor Operated)</p> <p>सिगनल स्लॉट नियंत्रण (मोटर चालित)</p>	
<p>Signal No.3 Of East Cabin Slot Controlled By SM's Slide No.2 And West Cabin Slot Lever No. 19</p> <p>सिगनल क्रं.3 पूर्व केबिन स्लॉट नियंत्रित स्टे.मा. स्लाइड क्रं. 2 पश्चिम केबिन स्लॉट लीवर क्रं. 19</p>	
<p>Signal with Route Indicator</p> <p>सिगनल, रूट इंडिकेटर के साथ</p>	
<p>Upper Quadrant Semaphore Signal</p> <p>ऊपर डइने वाला सिगनल</p>	

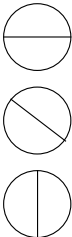
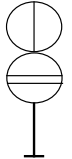
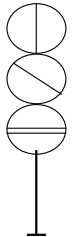
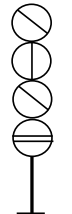
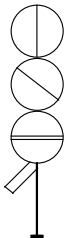
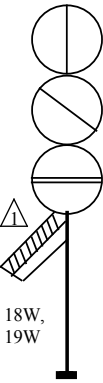
COLOUR LIGHT SIGNALS

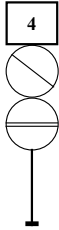
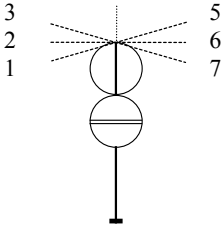
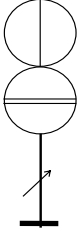
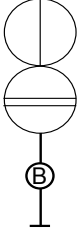
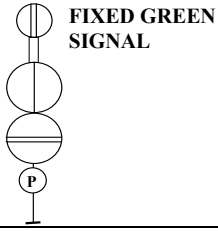
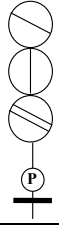
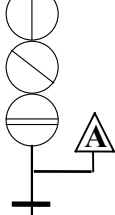

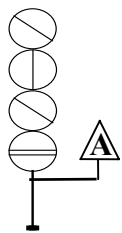
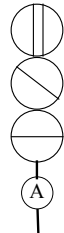
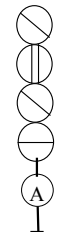
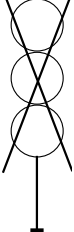
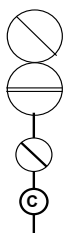
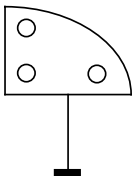
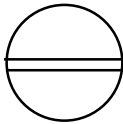

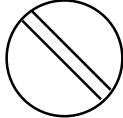
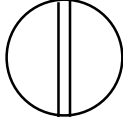
DESCRIPTION	SYMBOLS						
<p>Colour Light Signal Aspect</p> <table style="display: inline-table; vertical-align: middle;"> <tr> <td style="border-right: 1px solid black; padding-right: 5px;">Red</td> <td>लाल</td> </tr> <tr> <td style="border-right: 1px solid black; padding-right: 5px;">Yellow</td> <td>पीला</td> </tr> <tr> <td style="border-right: 1px solid black; padding-right: 5px;">Green</td> <td>हरा</td> </tr> </table> <p>कलर लाइट सिगनल के संकेत</p>	Red	लाल	Yellow	पीला	Green	हरा	
Red	लाल						
Yellow	पीला						
Green	हरा						
<p>Two aspect colour light stop signal</p> <p>दो संकेती कलर लाइट स्टॉप सिगनल</p>							
<p>Three aspect colour light stop signal</p> <p>तीन संकेती कलर लाइट स्टॉप सिगनल</p>							
<p>Four aspect colour light stop signal</p> <p>चार संकेती कलर लाइट स्टॉप सिगनल</p>							
<p>Slot control Colour light signal</p> <p>स्लॉट द्वारा नियंत्रित कलर लाइट सिगनल</p>							
<p>3 Aspect colour light signal No. $\frac{3}{4}$ of East Cabin (E/C) Slot controlled by SM's Slide No. $\triangle 1$, west cabin (W/C) slot lever No. 18/19</p> <p>तीन संकेती कलर लाइट सिगनल नं. $\frac{3}{4}$ पूर्व केबिन स्लॉट नियंत्रित स्टे.मा. स्लाईड नं. 1, पश्चिम केबिन स्लॉट लीवर नं. 18W /19W</p>							

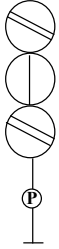

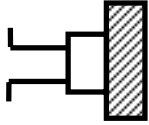

DESCRIPTION	SYMBOLS
<p>2 Aspect C.L.S. with stencil type/ Multi lamp type Route indicator</p> <p>दो संकेती कलर लाइट सिगनल, स्टेंसिल टाइप / मल्टी लैम्प टाइप रूट इंडीकेटर के साथ</p>	
<p>C.L.S. with junction type/ Direction type Route indicator</p> <p>कलर लाइट सिगनल जंक्शन टाइप/डायरेक्शन टाइप रूट इंडीकेटर के साथ</p>	
<p>Colour light signal Line clear control by Token</p> <p>कलर लाइट सिगनल लाइन क्लियर नियंत्रण टोकन द्वारा</p>	
<p>Colour light signal Line clear control by lock and block</p> <p>कलर लाइट सिगनल लाइन क्लियर नियंत्रण लॉक एवं ब्लॉक द्वारा</p>	
<p>Colour light Warner signal</p> <p>कलर लाइट वॉर्नर सिगनल</p>	
<p>Colour light distant signal</p> <p>कलर लाइट डिस्टेंट सिगनल</p>	
<p>Semi automatic three aspect Colour light signal</p> <p>तीन संकेती सेमी ऑटोमेटिक कलर लाइट सिगनल</p>	

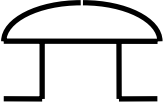
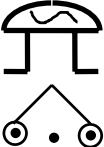
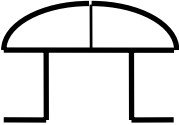
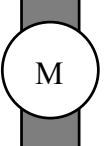
DESCRIPTION	SYMBOLS
Semi automatic four aspect Color light signal चार संकेती, सेमी ऑटोमेटिक कलर लाइट सिगनल	
Automatic Colour light signal, three aspect तीन संकेती ऑटोमेटिक कलर लाइट सिगनल	
Automatic Colour light signal, four aspect चार संकेती ऑटोमेटिक कलर लाइट सिगनल	
Colour light signal not in use कलर लाइट सिगनल जो प्रयोग में नहीं हैं	
Calling on signal below a Stop signal रोक सिगनल के नीचे लगा कॉलिंग ऑन सिगनल	
Position light type Shunt Signal पोजीशन लाइट टाईप शन्ट सिगनल	
Normal red aspect for stop signal नार्मल लाल एस्पैक्ट, रोक सिगनल के लिये	

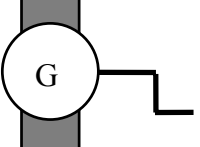

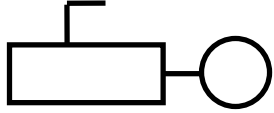

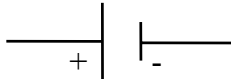
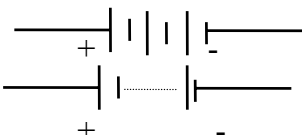
DESCRIPTION	SYMBOLS
<p>Normal yellow aspect for distant signal</p> <p>नार्मल पीला एस्पैक्ट डिस्टैंट सिगनल के लिये</p>	
<p>Normal green aspect for automatic Colour Light Sig.</p> <p>नार्मल हरा एस्पैक्ट, ऑटोमेटिक कलर लाइट सिगनल के लिये</p>	
<p>Position light type shunt signal below a stop signal</p> <p>रोक सिगनल के नीचे लगा पोजीशन लाइट टाइप शन्ट सिगनल</p>	
<p>Normal aspect double yellow of a distant signal in rajdhani route(where double distant signal is provided)</p> <p>राजधानी रुट पर जहाँ दो डिस्टैंट लगे हों, बाहरी डिस्टैंट सिगनल का नार्मल एस्पैक्ट</p>	

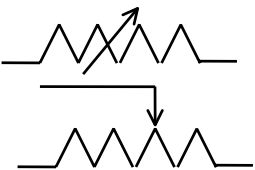
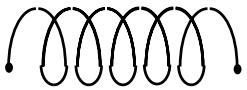
GENERAL SYMBOLS

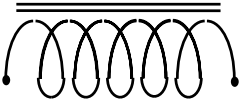
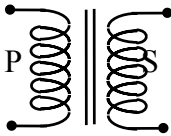
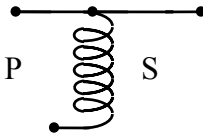
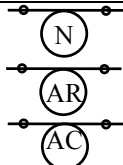
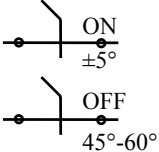
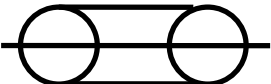
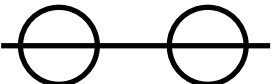
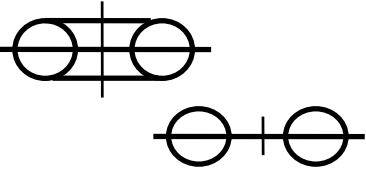
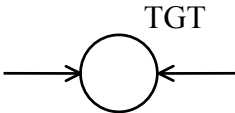

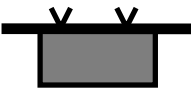
DESCRIPTION	SYMBOLS
Receiver रिसीवर	
Transmitter ट्रांसमीटर	
Switch स्विच	
D.C.Bell डी.सी. घंटी	
A.C.Bell ए.सी. घंटी	
Block Bell ब्लॉक घंटी	
Motor मोटर	
Generator जनरेटर	
Hand Generator Magneto हैण्ड जनरेटर मैग्नेटो	

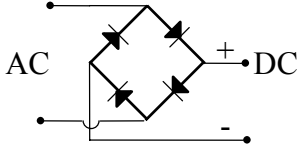
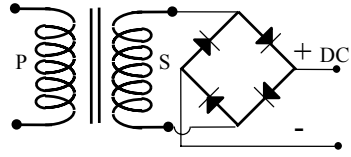

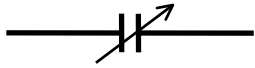
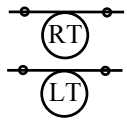
DESCRIPTION	SYMBOLS
Electric point machine विद्युत कांटा मशीन	
Dual control electric point machine ड्यूल कन्ट्रोल विद्युत कांटा मशीन	
L.D. एल. डी.	
Fuse फ्यूज	
Cell सेल	
Battery बैटरी	
Resistance प्रतिरोध	
Variable Resistance वेरिऐबल प्रतिरोध	
Coil कुण्डली	

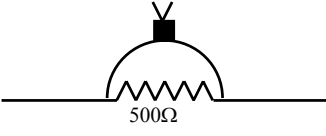
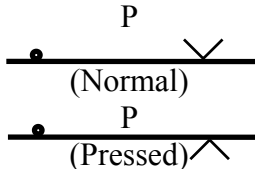
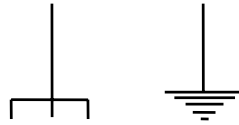
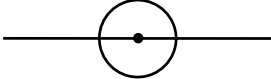
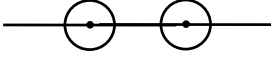
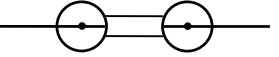
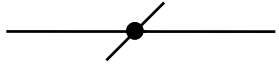
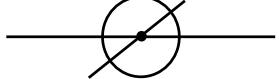
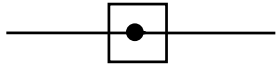
DESCRIPTION	SYMBOLS
Choke Coil चोक कुण्डली	
Transformer ट्रॉसफॉर्मर	
Auto Transformer ऑटो ट्रॉसफॉर्मर	
Lever circuit controller contacts लीवर सर्किट कन्ट्रोलर कांटेक्ट	
Arm circuit controller contacts आर्म सर्किट कन्ट्रोलर कांटेक्ट	
Normal detection contact नॉर्मल डिटेक्शन कांटेक्ट	
Reverse detection contact रिवर्स डिटेक्शन कांटेक्ट	
Detection contacts with Bolt detection बोल्ट डिटेक्शन के साथ डिटेक्टर कांटेक्ट	
TGT Contact टी.जी.टी. कांटेक्ट	

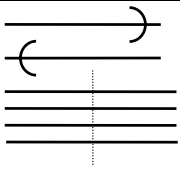
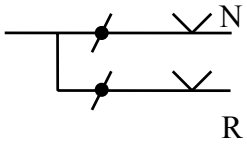

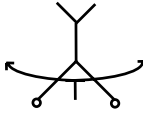
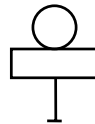
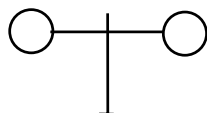
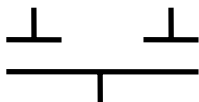
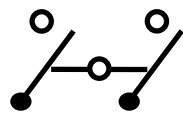
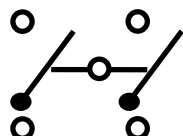

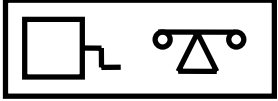

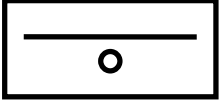

DESCRIPTION	SYMBOLS
W.M Tradle व्हील मेक ट्रेडिल	
W.B Tradle व्हील ब्रेक ट्रेडिल	
Special contact स्पेशल कॉन्टेक्ट	
Rectifier रेक्टिफायर	
Bridge Rectifier ब्रिज रेक्टिफायर	
Battery Charger बैटरी चार्जर	
Condensor कन्डेंसर	
Variable Condenser वेरिऐबल कन्डेंसर	
Rotary switch रोटरी स्विच	









DESCRIPTION	SYMBOLS
Thermostate contact थर्मोस्टेट कांटेक्ट	
Push button contact पुश बटन कांटेक्ट	
Earth अर्थ	
Terminal टर्मिनल	
Two way Terminal दू वे टर्मिनल	
Two way Terminal along with open strip दू वे टर्मिनल खुलने वाली पत्ती के साथ	
Rack terminal रैक टर्मिनल	
Panel Terminal पैनल टर्मिनल	
Main Board terminal मेन बोर्ड टर्मिनल	









DESCRIPTION	SYMBOLS
Boundry line सीमा रेखा	
Flasher relay contact फ्लैशर रिले कांटेक्ट	
Location Box लोकेशन बॉक्स	
Flashing supply फ्लैशिंग सप्लाइ	
Road crossing signal (Audible) सुनाई देने वाला रोड सिगनल	
Road crossing signal (Visual) दिखाई देने वाला रोड सिगनल	
Three plate condensor तीन प्लेट का केपेसिटर	
Double pole single throw (DPST) switch डबल पोल, सिंगल थ्रो स्विच	
Double pole double throw (DPST) switch डबल पोल, डबल थ्रो स्विच	









DESCRIPTION	SYMBOLS
Telephone alongwith cranck handle box क्रेंक हैंडल बॉक्स के साथ टेलीफोन	
Ground lever frame ग्राउन्ड लीवर फ्रेम	G.F. 
Cabin केबिन	









SIGNALLING RELAYS









DESCRIPTION	SYMBOLS
Relay रिले	
Indicator इंडिकेटर	
Lamp लैम्प	
Reverser रिवर्सर	
Bell घंटी	
Slot Relay स्लॉट रिले	
Slot indicator स्लॉट इंडिकेटर	
Slot stick relay स्लॉट स्टिक रिले	
Bell relay घंटी रिले	





DESCRIPTION	SYMBOLS
Bell stick relay बेल स्टिक रिले	
Stick relay स्टिक रिले	
Proving relay or repeating relay प्रूविंग रिले	
Track relay ट्रैक रिले	
Track proving relay ट्रैक प्रूविंग रिले	
Track stick relay ट्रैक स्टिक रिले	
Track indicator ट्रैक इंडिकेटर	
Track indication lamp ट्रैक इंडिकेशन लैम्प	
Point Relay प्वाईट रिले	

DESCRIPTION	SYMBOLS
Normal point Relay सामान्य प्वाईट रिले	
Reverse point Relay रिवर्स प्वाईट रिले	
Point indication relay प्वाईट इंडिकेशन रिले	
Normal point indication relay नार्मल प्वाईट इंडिकेशन रिले	
Reverse point indication relay रिवर्स प्वाईट इंडिकेशन रिले	
Normal point indication lamp नार्मल प्वाईट इंडिकेशन लैम्प	
Reverse point indication lamp रिवर्स प्वाईट इंडिकेशन लैम्प	
Signal relay सिगनल रिले	
Block stick relay ब्लॉक स्टिक रिले	

DESCRIPTION	SYMBOLS
Block checking relay ब्लॉक चैकिंग रिले	
Caution aspect control relay चेतावनी संकेत नियंत्रक रिले	
Attention aspect control relay सजकता संकेत नियंत्रक रिले	
Green clear aspect control relay पूर्ण गति संकेत नियंत्रक रिले	
Route relay रूट रिले	
Red signal lamp लाल सिगनल लैम्प	
Yellow signal lamp पीला सिगनल लैम्प	
Double yellow signal lamp दो पीला सिगनल लैम्प	
Green signal lamp हरा सिगनल लैम्प	

DESCRIPTION	SYMBOLS
Route signal lamp रूट सिगनल लैम्प	
Slow to release relay स्लो टू रिलीज रिले	
Lamp checking relay लैम्प चैकिंग रिले	
Red lamp checking relay रैड लैम्प चैकिंग रिले	
Yellow lamp checking relay एक पीला लैम्प चैकिंग रिले	
Double yellow lamp checking relay दो पीला लैम्प चैकिंग रिले	
Green lamp checking relay हरा लैम्प चैकिंग रिले	
Route lamp checking relay रूट लैम्प चैकिंग रिले	
Red signal indication lamp रैड सिगनल इंडिकेशन लैम्प	

DESCRIPTION	SYMBOLS
Single yellow signal indication lamp एक पीला सिगनल इंडिकेशन लैम्प	
Double yellow signal indication lamp दो पीला सिगनल इंडिकेशन लैम्प	
Green signal indication lamp हरा सिगनल इंडिकेशन लैम्प	
Route signal indication lamp रूट सिगनल इंडिकेशन लैम्प	
Slow to pick up relay स्लो टू पिक अप रिले	
Slow to pick up and slow to release relay स्लो टू पिक अप तथा स्लो टू रिलीज रिले	
Button बटन	
Point button प्वाइंट बटन	
Group point button ग्रुप प्वाइंट बटन	

DESCRIPTION	SYMBOLS
Normal point group button नार्मल प्वाइंट ग्रुप बटन	
Reverse point group button रिवर्स प्वाइंट ग्रुप बटन	
Emergency track button इमरजेंसी ट्रैक बटन	
Emergency point button इमरजेंसी प्वाइंट बटन	
Emergency group signal replacement button इमरजेंसी ग्रुप सिगनल रिप्लेसमेंट बटन	









BRITISH RRI

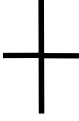





COLOUR	BUTTON	DESCRIPTION
Red	GN	Signal knob
Yellow	SGN	Shunt signal knob
Black	K-IN	Siding control knob
Red or chocolate	LXN/LCN	L-xing gate control knob
Black	CH-N	Crank handle control knob
Black	WN	Point control knob
Black	WWN	Group point button
Red	COS-N	Calling on signal control knob
Red with white bar	King	King knob for automatic working
Blue/Black	Day/Night	Power control knob for day/night
Red	Power ack.	Power failure acknowledge push button
White/Black	UN	Route push button
Blue/Green	YN	Slot knob
Green	App-Ack	Approach acknowledge push button
Red	Cancellation	Cancellation push button
<p>Note:</p> <ol style="list-style-type: none"> 1. Red coloured signal knob two position used in D/L 2. Red coloured signal knob three position used in S/L (optional) 3. Black coloured point knob two position used in PI and three position in RRI. 		



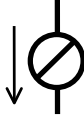

SIEMEN'S RRI

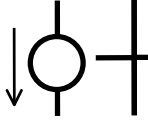

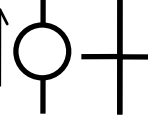

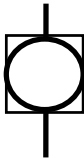
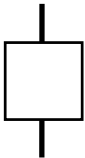
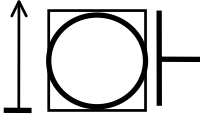

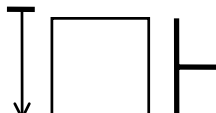
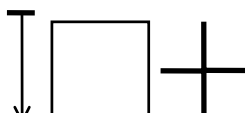

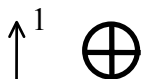
COLOUR	BUTTON	DESCRIPTION
Red	GN	Signal push button
Blue	WN	Point push button
Grey	UN	Route push button
Green	YN	Slot push button
Blue	WWN	Common point button
Blue	EWN	Emergency point button
Grey	EUUYN	Emergency route release button
Blue with white dot on top	EUYN	Emergency route section release button
Red	EGGRN	Emergency button replacing signals at "ON"
Grey	OYN	Over-lap release button
Grey	YYN	Group slot release button
Grey / Green	YYRN	Slot release return button
Blue	CHYN	Crank handle release button
Blue	CHYRN	Crank handle release return button
White	Day/Night	Day/Night intensity button (02 nos)
Grey	1,2,3,4	Panel indication illumination button
Red	GXYN	Signal lamp failure acknowledge button
Blue	WXYN	Point failure ack. button



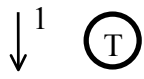

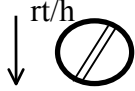

SIEMEN'S RRI

DESCRIPTION	SYMBOLS
Made contact or closed contact बना हुआ कांटेक्ट	
Interrupted contact or open contact ओपन व खुला हुआ कांटेक्ट	
DC Neutral relay डी.सी. न्यूट्रल रिले	
Point control relay प्वाइंट कंट्रोल रिले	
Point detection relay प्वाइंट डिटेक्शन रिले	
Point lock relay प्वाइंट लॉक रिले	
Route relay रूट रिले	
Route checking relay रूट चैकिंग रिले	
Route lock relay रूट लॉक रिले	

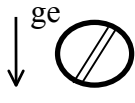

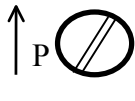

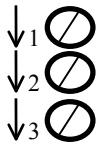

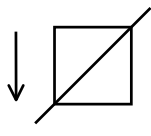

DESCRIPTION	SYMBOLS
Signal control relay सिगनल कन्ट्रोल रिले	
Lamp proving relay लैम्प प्रूविंग रिले	
Signal lock relay सिगनल लॉक रिले	
Signal control relay normally De-energised सिगनल कन्ट्रोल रिले नॉर्मली ड्रॉप अवस्था में	
Neutral relay normally energised न्यूट्रल रिले नॉर्मली पिक अप अवस्था में	
Relay normally de-energised contact made- (Back contact) बैक कांटेक्ट	
Relay normally de-energised contact open - (front contact) फ्रंट कांटेक्ट	
Relay normally energised contact made-(front contact) फ्रंट कांटेक्ट	
Relay normally energised contact open-(back contact) बैक कांटेक्ट	

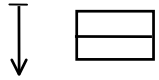



DESCRIPTION	SYMBOLS
Normal coil of an interlocked relay इंटरलॉकड रिले की नार्मल क्वाइल	
Reverse coil of an interlocked relay इंटरलॉकड रिले की रिवर्स क्वाइल	
Normal coil of an interlocked relay-contact made (front contact) इंटरलॉकड रिले की नार्मल क्वाइल का बना हुआ कांटेक्ट – (फ्रंट कांटेक्ट)	
Normal coil of an interlocked relay-contact open (back contact) इंटरलॉकड रिले की नार्मल क्वाइल का कटा हुआ कांटेक्ट – (बैक कांटेक्ट)	
Reverse coil of an interlocked relay-contact made (back contact) इंटरलॉकड रिले की रिवर्स क्वाइल का बना हुआ कांटेक्ट – (बैक कांटेक्ट)	
Reverse coil of an interlocked relay-contact open (front contact) इंटरलॉकड रिले की रिवर्स क्वाइल का कटा हुआ कांटेक्ट – (फ्रंट कांटेक्ट)	
Track relay ट्रैक रिले	
Track repeating relay (TPR) ट्रैक रिपिटिंग रिले	

DESCRIPTION	SYMBOLS
Second repeater for point track circuit clear proving relay प्लॉइंट ट्रैक सर्किट क्लीयर प्रूविंग रिले का द्वितीय रिपीटर	
Time element relay (JR) टाइम एलीमेंट रिले	
Helper relay No.1 to general time element relay (JPR1) हेल्पर रिले क्रं.1 जनरल टाइम एलीमेंट रिले	
Approach time element relay (AJTR) एप्रोच टाइम एलीमेंट रिले	
Signal lock stick relay (GLSR) सिगनल लॉक स्टिक रिले	
Red aspect lamp proving relay (RECR) (Automatic) रैड अस्पेक्ट लैम्प प्रूविंग रिले (ऑटोमेटिक)	
Clear aspect lamp proving relay (D/HECR) (Automatic) ऑफ अस्पेक्ट लैम्प प्रूविंग रिले (ऑटोमेटिक)	
Green aspect lamp proving relay (DECR)(Automatic) हरा अस्पेक्ट लैम्प प्रूविंग रिले (ऑटोमेटिक)	
Red aspect lamp proving relay (RE(Mn)CR) रैड अस्पेक्ट लैम्प प्रूविंग रिले	

DESCRIPTION	SYMBOLS
Yellow aspect lamp proving relay (HECR) पीला अस्पेक्ट लैम्प प्रूविंग रिले (HECR)	
Green aspect lamp proving relay (DECR) हरा अस्पेक्ट लैम्प प्रूविंग रिले (DECR)	
Route indication lamp checking relay (UECR) रूट इंडिकेशन लैम्प चैकिंग रिले(UECR)	
Signal push button checking relay (GNCR) सिगनल पुश बटन चैकिंग रिले(GNCR)	
Signal push button relay (GNR) सिगनल पुश बटन रिले(GNR)	
Emergency signal push button relay (EGNR) इमरजेंसी सिगनल पुश बटन रिले(EGNR)	
Signal relay no. 1,2,3 (GR1,GR2,GR3) सिगनल रिले (GR1, GR2, GR3)	
Signal initiating relay (GZR) सिगनल इनीशीऐटिंग रिले(GZR)	
Reverse coil of signal lock relay (G(R)LR) सिगनल लॉक रिले की रिवर्स क्वाइल(G(R)LR)	

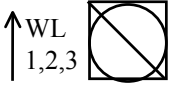
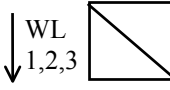
DESCRIPTION	SYMBOLS
Normal coil of signal lock relay (G(N)LR) सिगनल लॉक रिले की नार्मल क्वाइल(G(N)LR)	
Route clear checking relay (DUCR) रूट क्लीयर चैकिंग रिले (DUCR)	
Route push buttons checking relay (UNCR) रूट पुश बटन चैकिंग रिले (UNCR)	
Route initiating relay (Z1UR1) रूट इनीशीएटिंग रिले(Z1UR1)	
Route push button relay (UNR) रूट पुश बटन रिले(UNR)	
Diversion selector relay (Z1UR1) डायवरजन सलेक्टर रिले(Z1UR1)	
Emergency route group release relay (EUUYR) इमरजेंसी रूट ग्रुप रीलीज रिले(EUUYR)	
Zonal route permissibility checking relay (ZDUCR) जोनल रूट परमीसीबीलीटी चैकिंग रिले(ZDUCR)	
Isolation point control relay (UZ4R) आईसोलेशन प्वाइंट कन्ट्रोल रिले(UZ4R)	

DESCRIPTION	SYMBOLS
Route setting relay reverse coil (U(R)S) रूट सेटिंग रिवर्स क्वाइल(U(R)S)	
Route normalising relay normal coil (U(N)S) रूट नार्मलाइजिंग रिले नार्मल क्वाइल (U(N)S)	
Point push button checking relay (WNCR) प्वाइंट पुश बटन चैकिंग रिले (WNCR)	
Point detector relay No. 1 (WKR1) प्वाइंट डिटेक्टर रिले क्रं 1(WKR1)	
Point button relay (WNR) प्वाइंट बटन रिले (WNR)	
Emergency point push button relay (EWNR) इमरजेंसी प्वाइंट पुश बटन रिले (EWNR)	
Point group push button relay (WWNR) प्वाइंट ग्रुप पुश बटन रिले(WWNR)	
Switching relay for point chain group (Z3WR) प्वाइंट चेन ग्रुप की स्विचिंग रिले(Z3WR)	
Point contactor relay (WR) प्वाइंट कांटेक्टर रिले(WR)	

DESCRIPTION	SYMBOLS
Point to normal operation controlling relay (N) WLR प्याइंट के नार्मल ऑपरेशन हेतु कंट्रोलिंग रिले	
Point to reverse operation controlling relay (R) WLR प्याइंट के रिवर्स ऑपरेशन हेतु कंट्रोलिंग रिले (R)WLR	
Point lock stick relay (WLR) प्याइंट लॉक स्टिक रिले(WLR)	
Initiating relay for normal movement of points (Z1NWR) इनीशिएटिंग रिले प्याइंट के नार्मल मूवमेंट के लिये (Z1NWR)	
Initiating relay for reverse movement of points (Z1RWR) इनीशिएटिंग रिले प्याइंट के रिवर्स मूवमेंट के लिये (Z1RWR)	
Point end position indicating relay (WKR3) प्याइंट एण्ड पोजीशन इंडीकेशन रिले(WKR3)	